

12

Lungs Surgery

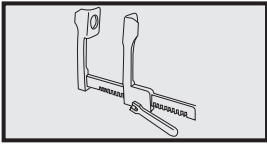



DC12-001-23

DC12-003-23

DC12-005-23

DC12-007-23

left

right

Sarot
DC12-001-23 - DC12-007-23
23 cm/9"

ACMA
INTERNATIONAL

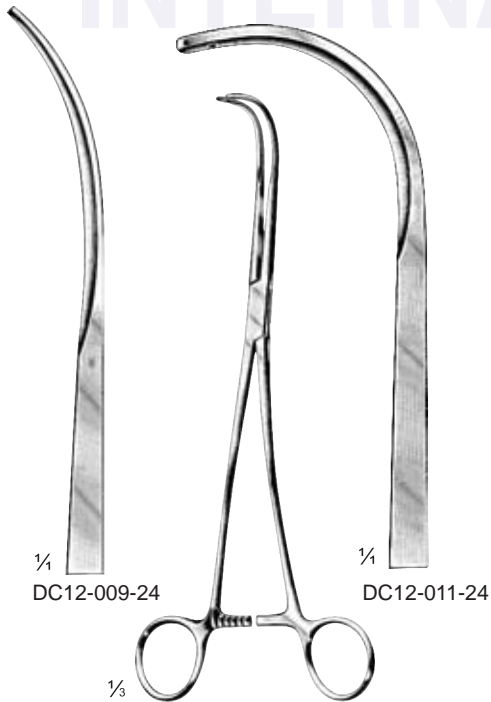

1/4
DC12-009-24

1/4
DC12-011-24

1/3
Semb
DC12-009-24 - DC12-011-24
24 cm/9 1/2"

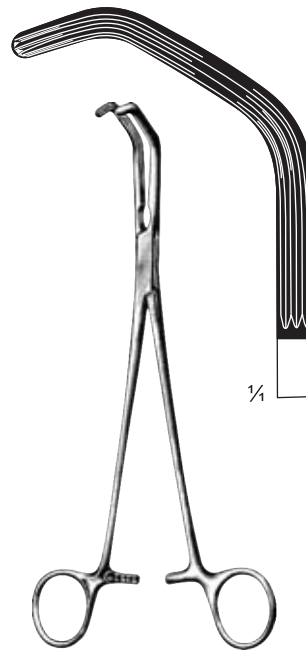

1/4

Price-Thomas
DC12-013-22
22 cm/8 3/4"

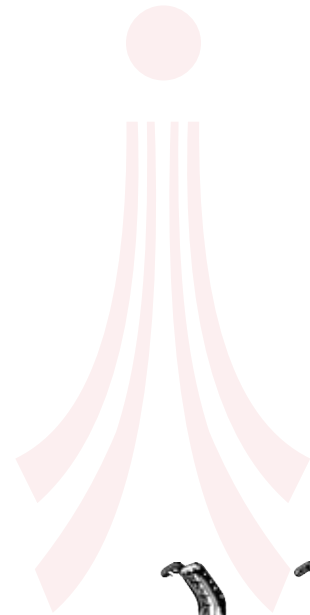

1/3
DC12-017-22

1/3
Price-Thomas
DC12-015-22
22 cm/8 3/4"

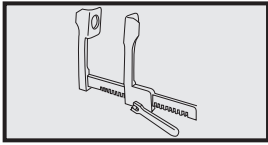

Rib Spreaders, Rib Contractors, Lung Spatulas



Allison
DC12-019-30 = 30 cm/12 3/4"
DC12-019-32 = 32 cm/13"



1/3
DC12-021-26
26 cm/10 1/4"



1/3
Crafoord
DC12-023-28
28 cm /11"



1/2
DC12-025-19
19 cm /7 1/2"



Bailey-Baby
DC12-027-14
14 cm/5 1/2"

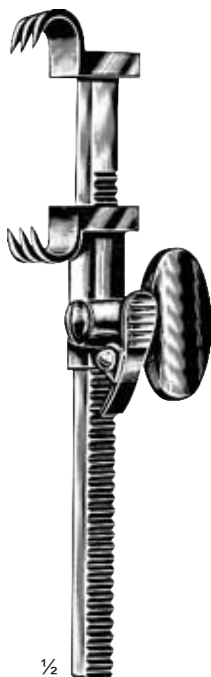

Bailey
DC12-029-16
16 cm/6 1/4"



Bailey-Gibbon
DC12-031-16
16 cm/6 1/4"

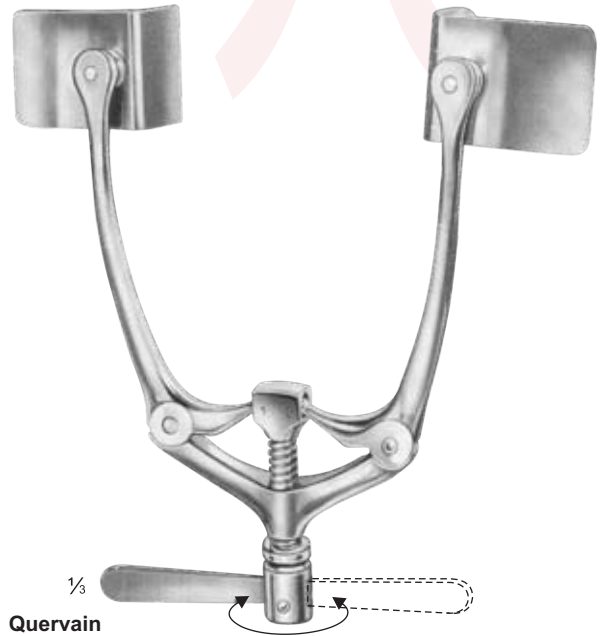

1/3
Quervain
a b c
DC12-033-00 35 mm 50 mm 180 mm
Rib Spreaders

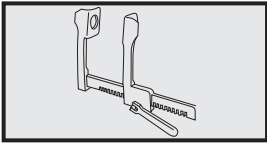

Rib Spreaders, stainless

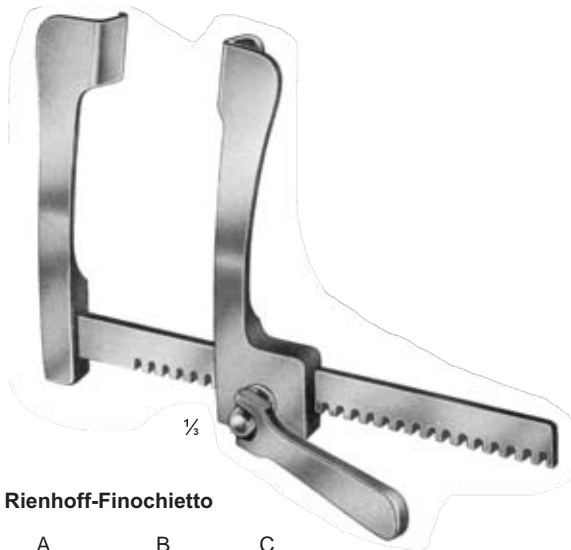
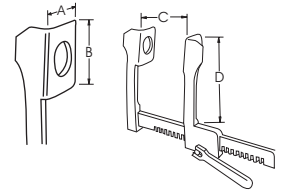

Rienhoff-Finochietto

A	B	C
21mm	26mm	150mm
DC12-035-26		

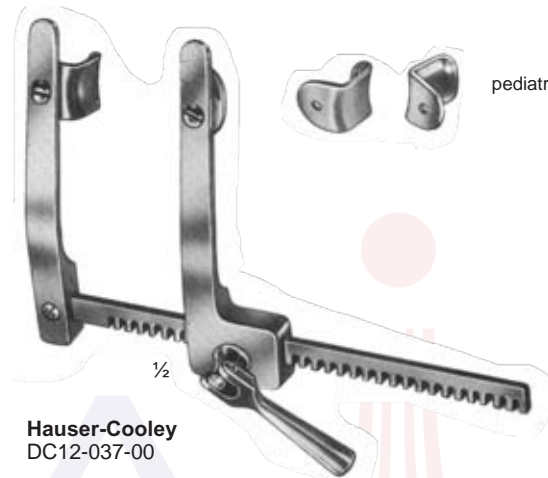

With swivel blades

pediatric size

Hauser-Cooley
DC12-037-00



for children

Finochietto-Baby-Haight

A	B	C
31mm/1¼"	31mm/1¼"	100mm/4"
DC12-039-10		

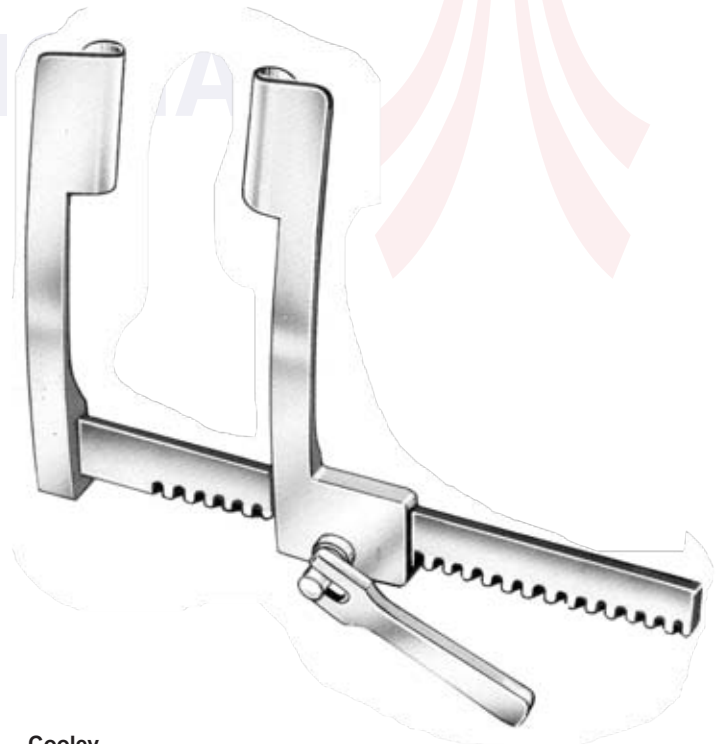

Cooley

	A	B	C
DC12-041-50	21mm, ¾"	44mm, 1 ¾"	150mm, 6"
DC12-041-00	37mm, 1 ½"	49mm, 1 7/8"	20mm/8"

DC12-041-50 for children
DC12-041-00 for adults

Rib Spreaders, stainless

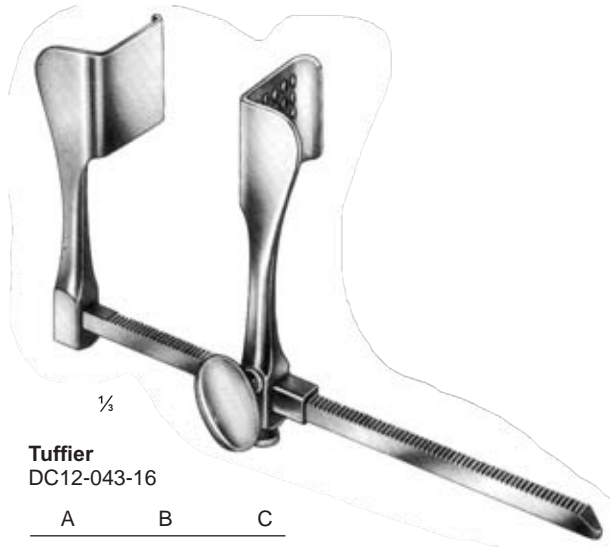
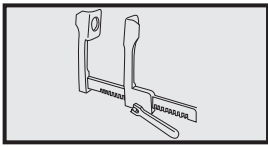

Tuffier
DC12-043-16

A	B	C
50mm	45mm	165mm

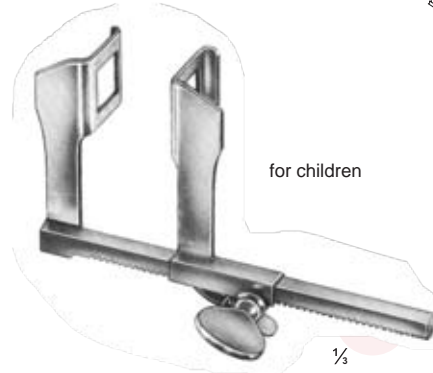
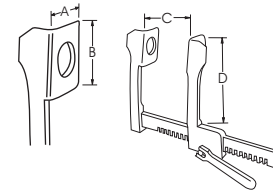

Baby-Haight
DC12-045-90

A	B	C	D
30mm	30mm	90mm	90mm

ACMA
INTERNATIONAL

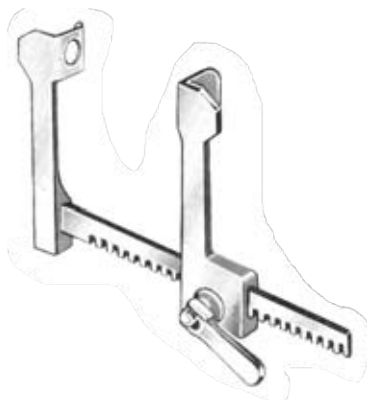

Finochietto-Infant
Finochietto-Baby

	A	B	C
DC12-047-36			36mm
DC12-047-75			75mm
DC12-049-00	7mm	7mm	100mm
DC12-049-25			125mm
DC12-049-50			150mm

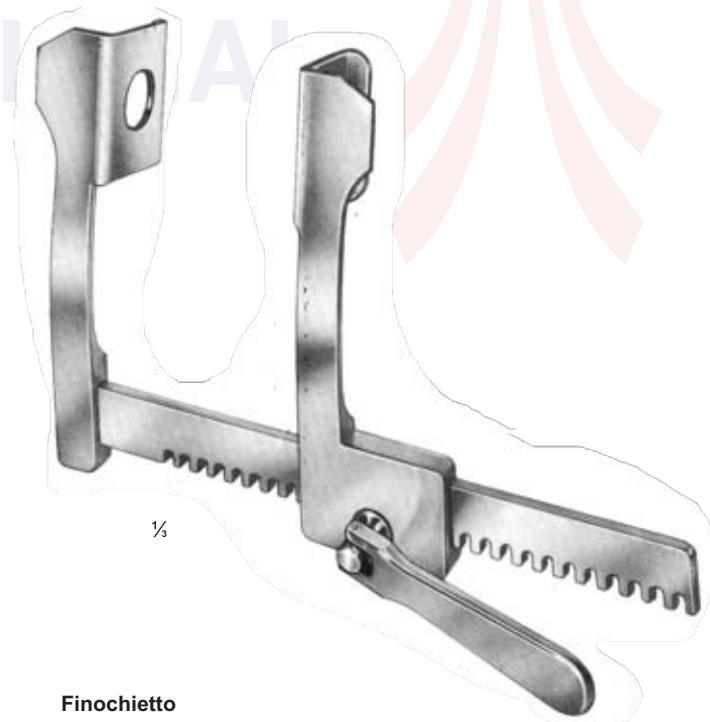

Finochietto

	A	B	C
DC12-051-38	38mm	44mm	150mm
DC12-053-52	52mm	62mm	75mm
DC12-053-65	65mm	85mm	75mm

Rib Spreaders, stainless

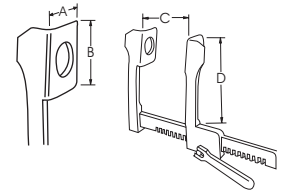
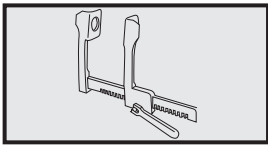

DeBakey
with 2 pairs of interchangeable blades

DC12-055-70
pediatric size

DC12-057-20
for children

DC12-059-00
for adults

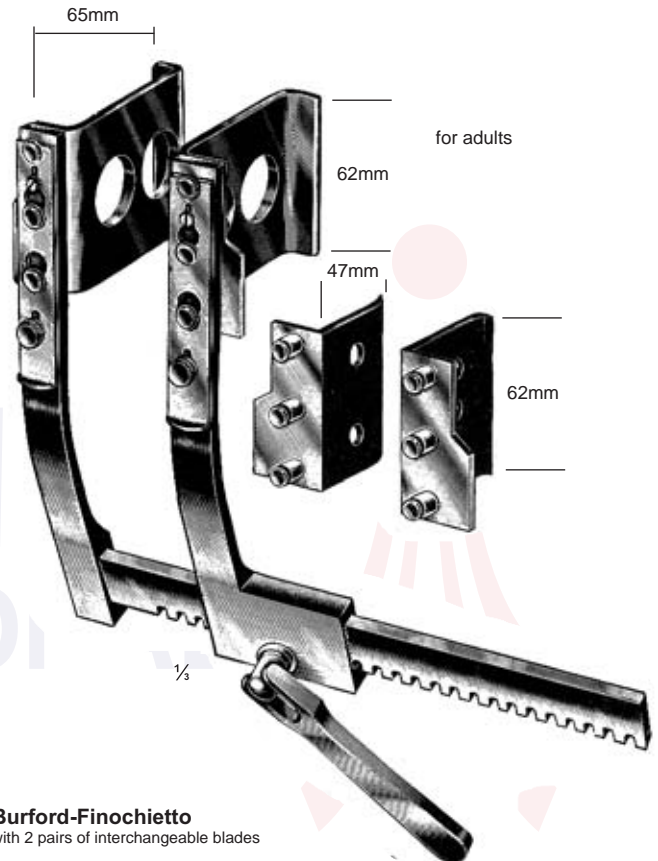

Burford-Finochietto
with 2 pairs of interchangeable blades

DC12-061-20

DC12-061-25

DC12-061-30

	1. pair of interchangeable blades		2. pair of interchangeable blades		blade opening
	Amm	Bmm	Amm	Bmm	Cmm
DC12-055-70	15	15	15	12	70
DC12-057-20	30	30	30	21	120
DC12-059-00	60	52	60	32	200
DC12-061-20	65	62	47	62	200
DC12-061-25	65	62	47	62	250
DC12-061-30	65	62	47	62	300

Sternotomy Spreaders

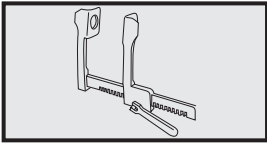

Morse Modif.
DC12-071-20

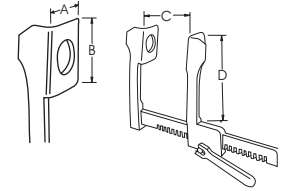

ACMA
INTERNATIONAL

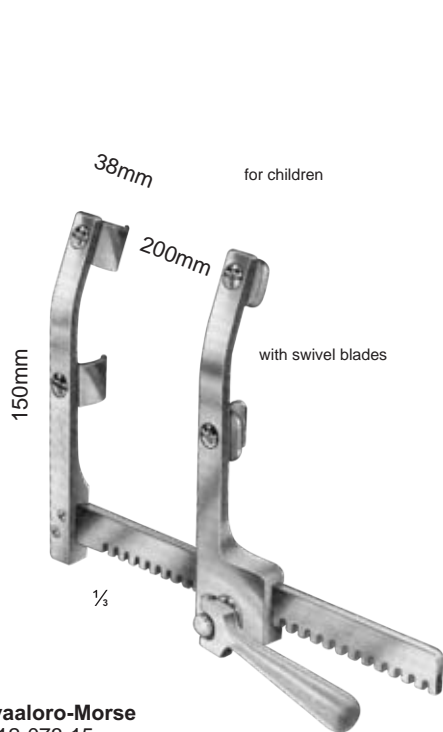
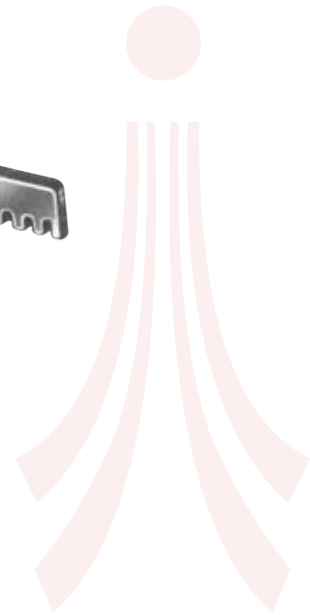

Favaaloro-Morse
DC12-073-15

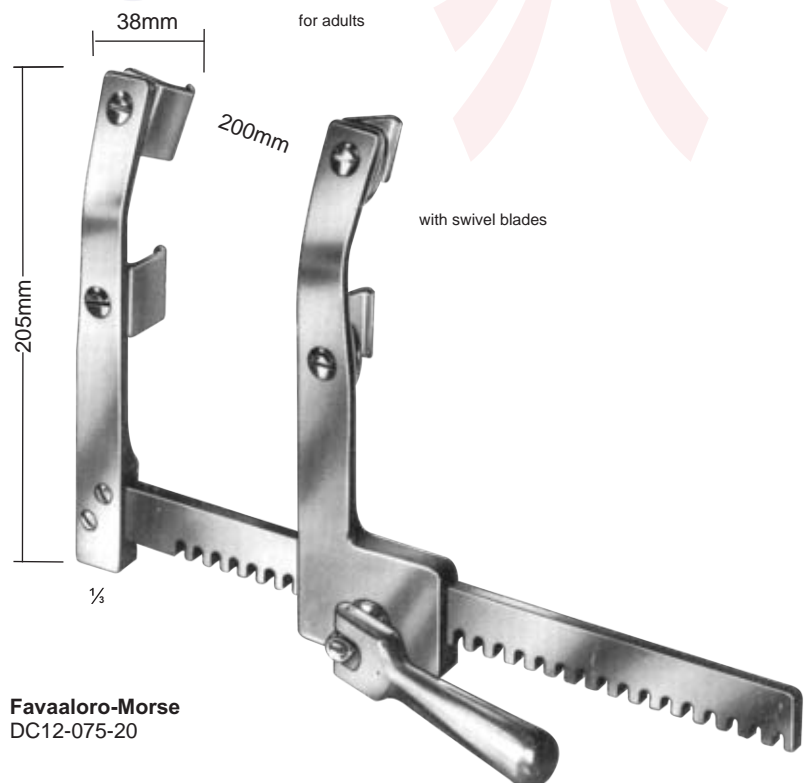

Favaaloro-Morse
DC12-075-20

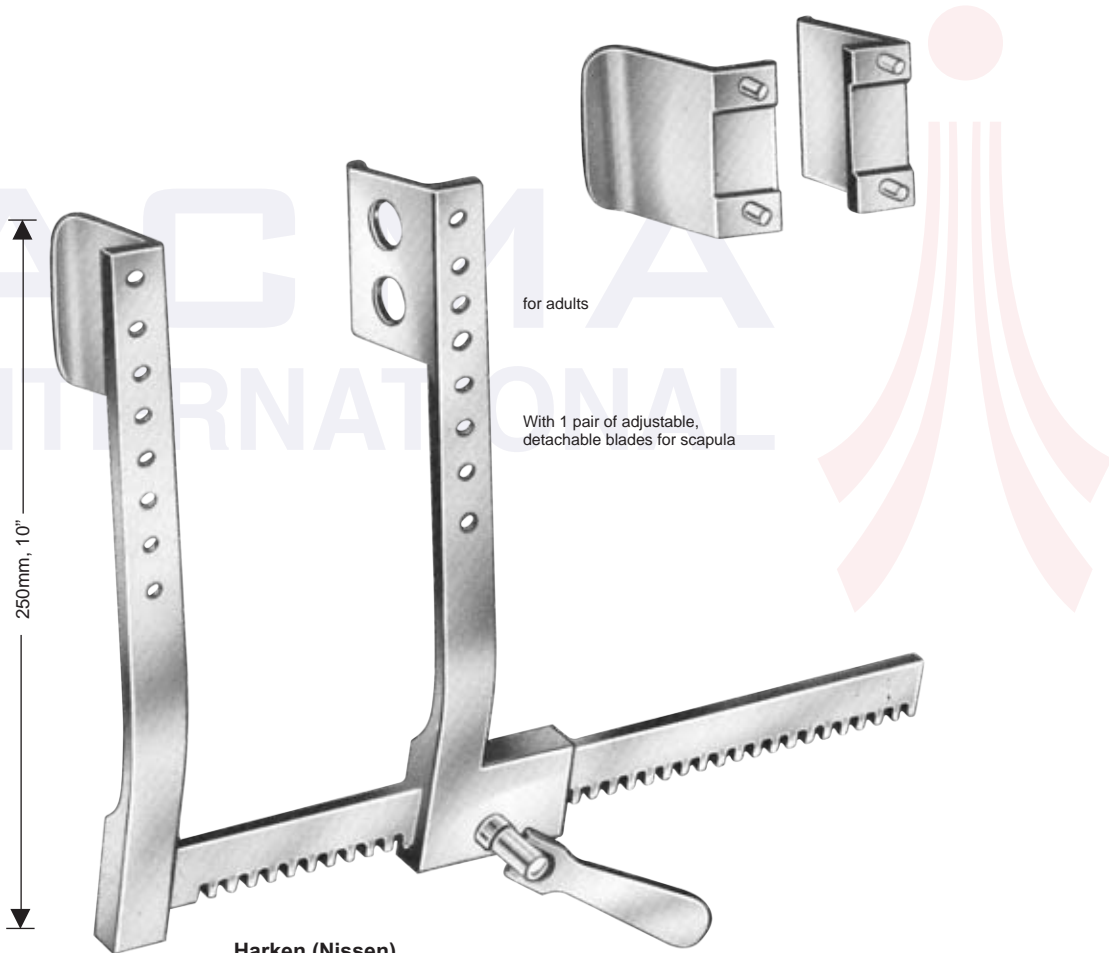
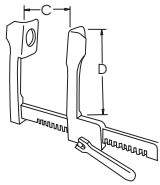
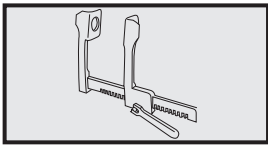

Harken (Nissen)

	un-removable blades		blades for scapula		blade opening
DC12-077-00	45mm/1¼"	75mm/3"	40mm/1½"	50mm/2"	200mm/8"
DC12-077-50	45mm/1¼"	75mm/3"	40mm/1½"	50mm/2"	250mm/10"

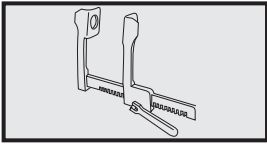

Bone and Rib Shears, Bone Punch



Rib Shears, Sternum Scissors, Sternum Chisel

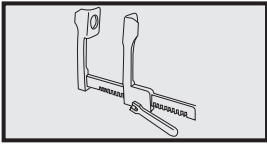

$\frac{1}{3}$
Sauerbruch-Fery
DC12-097-36
36 cm/14"

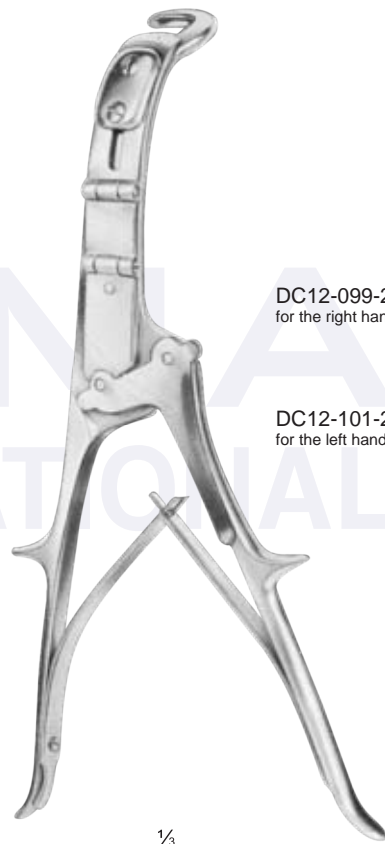

$\frac{1}{3}$
Brunner
DC12-099-28 - DC12-101-28
32 cm/12 $\frac{1}{2}$ "

DC12-099-28
for the right hand

DC12-101-28
for the left hand

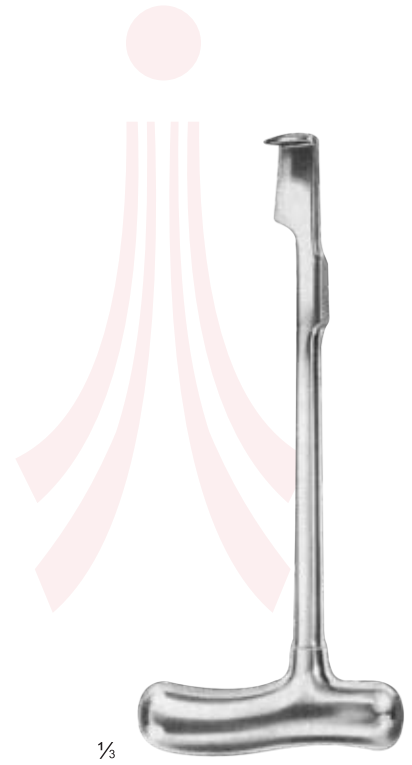

$\frac{1}{3}$
Lebsche
DC12-103-24
24.5 cm/9 $\frac{3}{4}$ "